

Data Sheet



Article number: 021300005021

Description: Sealing Clamp S 21 W1

Measures

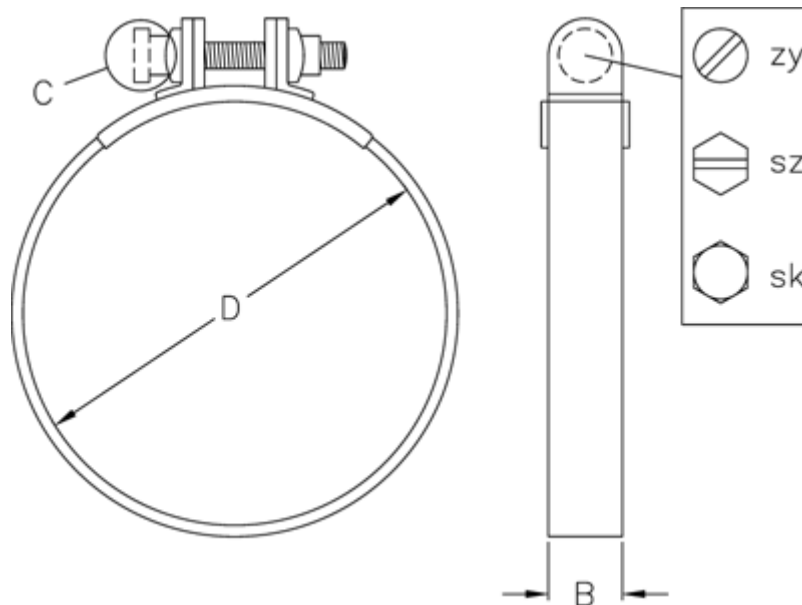

C (screw type) = SZ

Diameter D = 21

Width B = 12